

Pixel

FilaSorb™ 24

acoufelt
making quiet

Product Detail

Product	Pixel
Application	Wall and ceiling
Composition	100% polyester
Material	FilaSorb™
Recycled Content	60% min
Dimensions	1200 x 2780mm Custom size available upon request
Thickness	24mm +/- 10%

Guarantees

Warranty against defects 20 years*
Light fastness warranty 20 years*
*conditions apply



QuickShip available



Technical Data

Indoor Air Quality	SCS-EC10.3-2014 v4.0 meeting standard CDPH/EHLB Standard Method v.1.2-2017, ≤ 0.5mg/m ³
Light Fastness	ISO 105-B02, 6-7
Fire Test Method	AS/ISO 9705.1, Group 1 ASTM E84-17a, Class A EN 13501-1:2018

Sustainability

- Every square meter of FilaSorb™ diverts on average approximately 108 x 600ml PET drinking bottles from landfill
- LBC Red list free
- Phenol & formaldehyde free
- Total VOC's 0.5 mg/m³
- CDPH compliance
- Complies with building standards



Made from 60% min. recycled content



Declare Living Building Challenge compliant

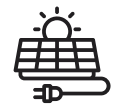

Generated using 40% solar energy



Recyclable at end-of-life



Declare.

Acoustic Performance

Sound Absorption ASTM E795
NRC 0.60 (no air gap)

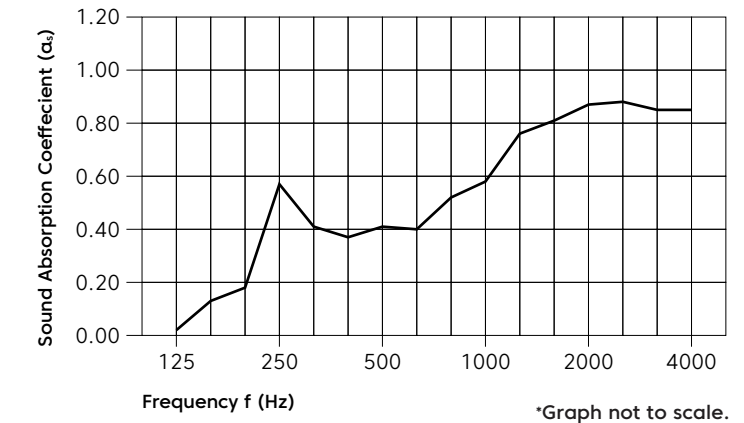

Frequency (Hz)	125	250	500	1000	2000	4000	NRC
αs	0.02	0.57	0.41	0.58	0.87	0.85	0.60

Colorways

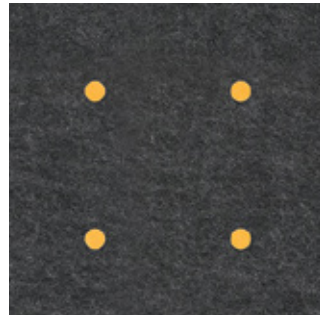

Charcoal + Butter

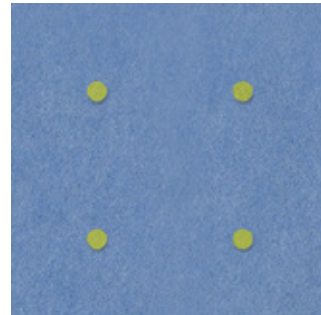

Marine + Wasabi

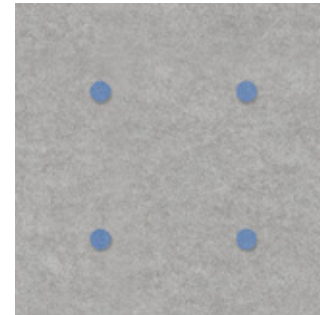

Metal + Marine

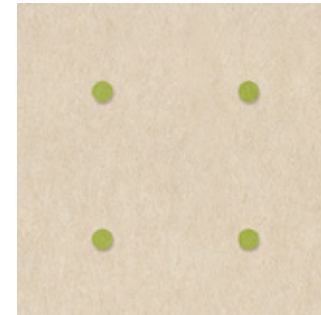

Pearl + Wasabi

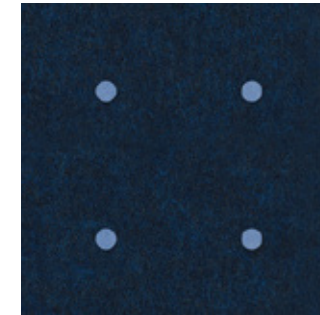

Midnight + Marine

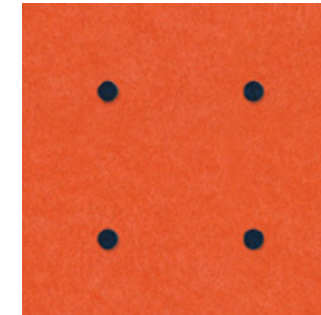

Carrot + Midnight

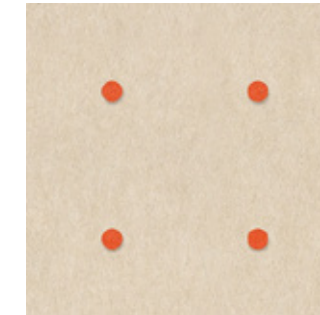

Pearl + Carrot

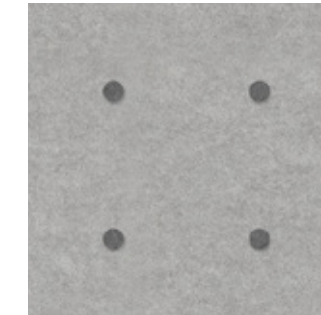

Metal + Slate

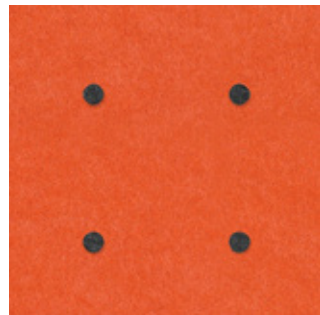

Carrot + Charcoal

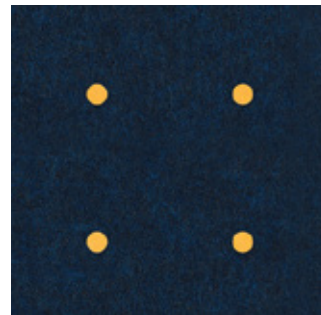

Midnight + Butter

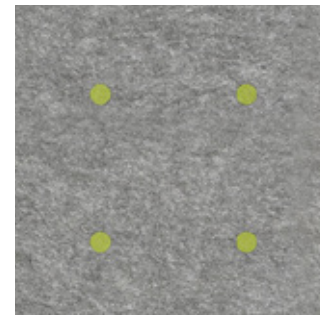

Grey + Wasabi

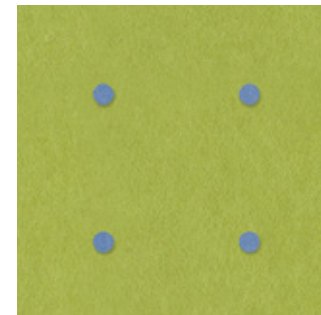

Wasabi + Marine

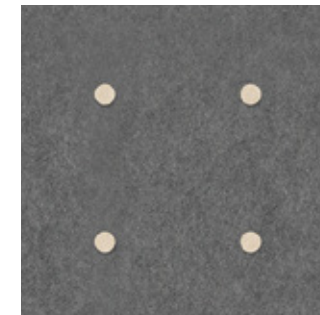

Slate + Pearl

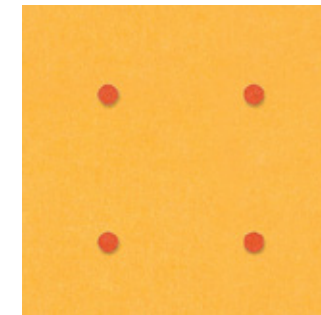

Butter + Carrot

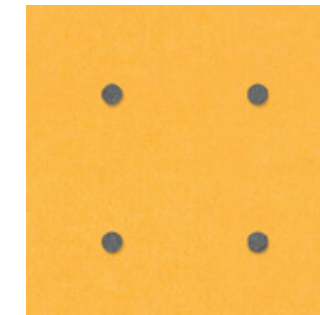

Butter + Slate

Custom colorways and combinations available on request

Mounting Methods

Constructive Adhesive

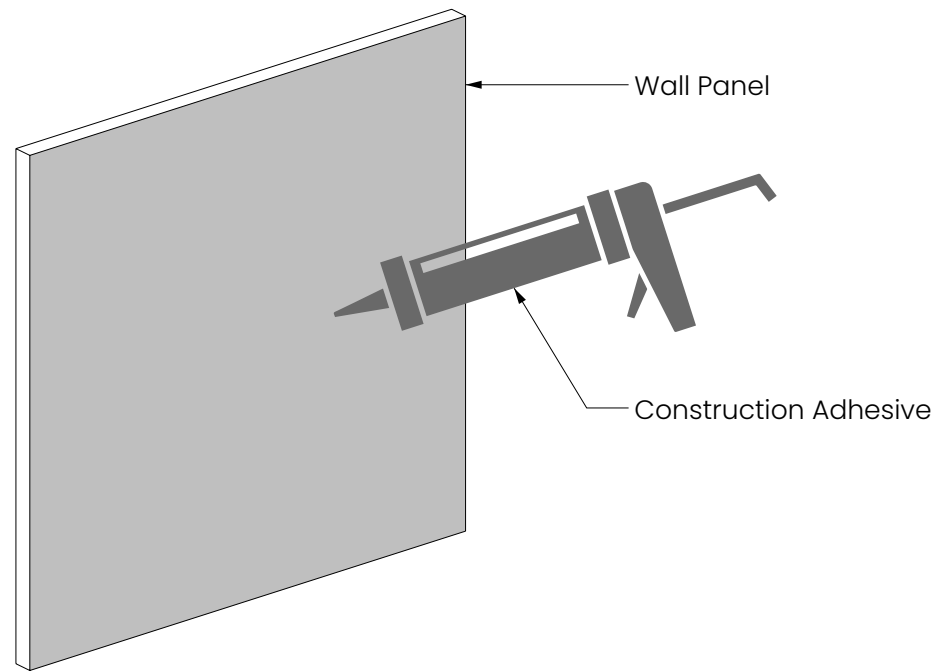

Z-Clip Mount

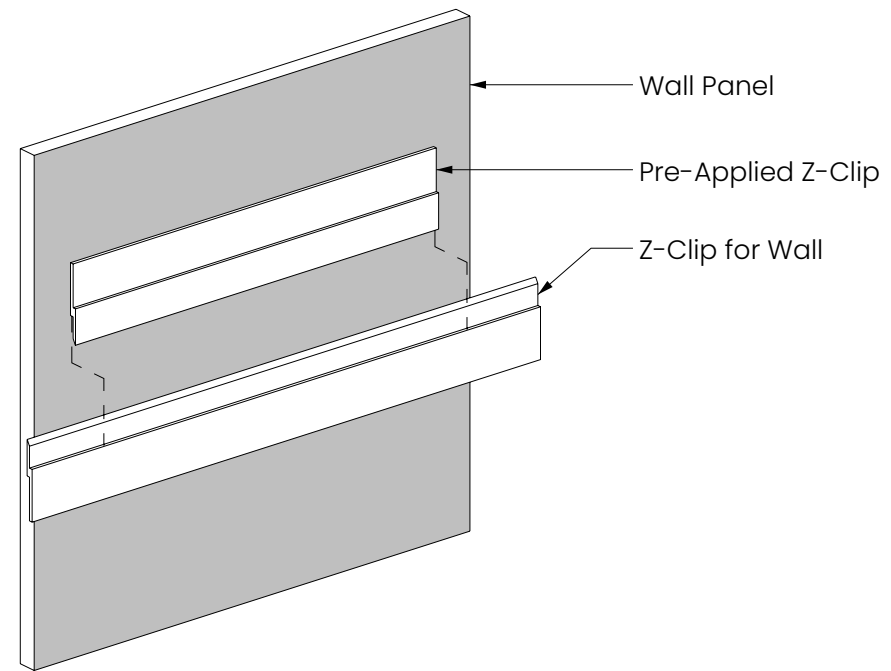

Pot Magnet Install

Wall Pot Magnet Install Metal Plate

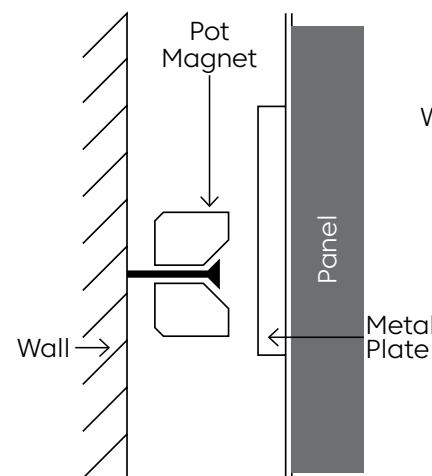

Wall Pot Magnet Install L Plate + Metal Plate

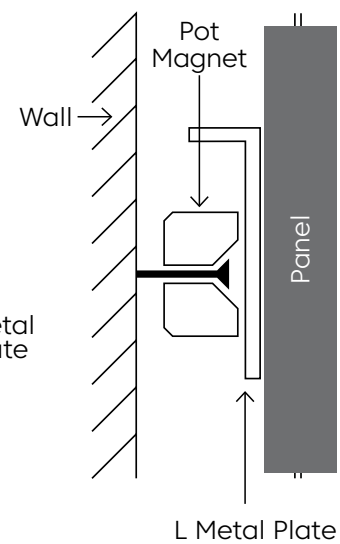

L Plate Wall + Metal Plate Configuration

○ L Metal Plate × Metal Plate

